

# SF|ZL strain relief plates

pluggable on 35 mm top hat rails



The strain relief plate SF|ZL is used for assembly on 35 mm top hat DIN rails. It can be used for strain relief of cables and conduits.

The SF|ZL range is based upon the [strain relief plate ZL](#), which is mounted on snap-in mounting feet for 35 mm top hat rails.



## Specifications

<b>Material</b>	Polyamide Snap foot: Spring steel
<b>Flame class</b>	UL94-V0, self-extinguishing
<b>Operating temperature</b>	-40 C° to 140 C°
<b>Properties</b>	silicone free, halogen free
<b>Mounting options</b>	Snap-in

## Advantages & benefits

- Strain relief according to EN 62444
- Fast and easy mounting
- Cost-effective solution
- High cable density
- Versatile utilisation

## Product types & sizes

SF|ZL 39

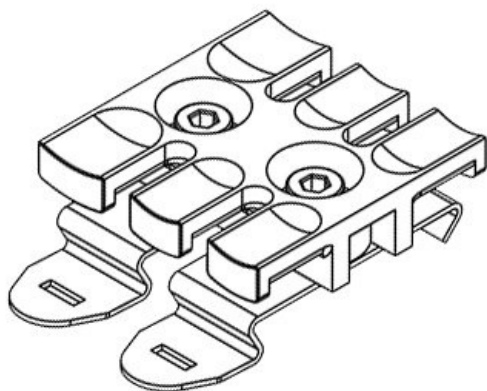

Part No.	<b>32351</b>	Mounting height	<b>11,4 mm</b>
EAN	<b>4251269301</b>	No. of teeth	<b>3</b>
Package quantity	<b>10</b>		
For max. no. of cables	<b>3</b>		
Length	<b>38,5 mm</b>		
Width	<b>51,7 mm</b>		
Height	<b>16 mm</b>		

## SF|ZL 60

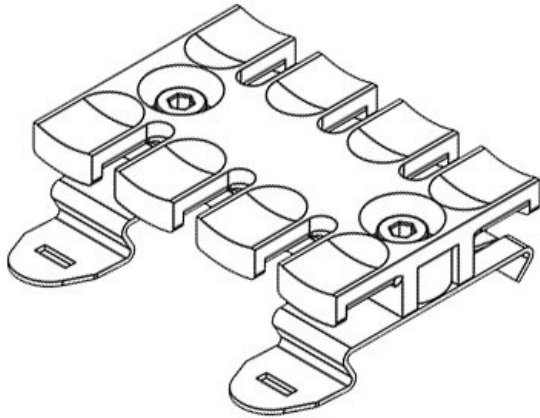

Part No.	<b>32352</b>	Mounting height	<b>11,4 mm</b>
EAN	<b>4251269301</b>	No. of teeth	<b>4</b>
Package quantity	<b>10</b>		
For max. no. of cables	<b>4</b>		
Length	<b>59,5 mm</b>		
Width	<b>51,7 mm</b>		
Height	<b>16 mm</b>		

## SF|ZL 70

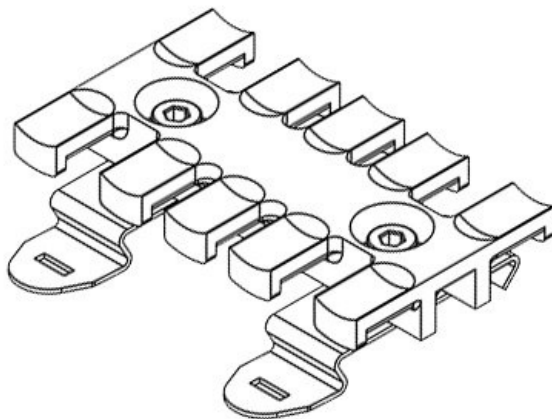

Part No.	<b>32353</b>	Mounting height	<b>11,4 mm</b>
EAN	<b>4251269301</b>	No. of teeth	<b>5</b>
Package quantity	<b>10</b>		
For max. no. of cables	<b>5</b>		
Length	<b>69,1 mm</b>		
Width	<b>51,7 mm</b>		
Height	<b>16 mm</b>		

## SF|ZL 87

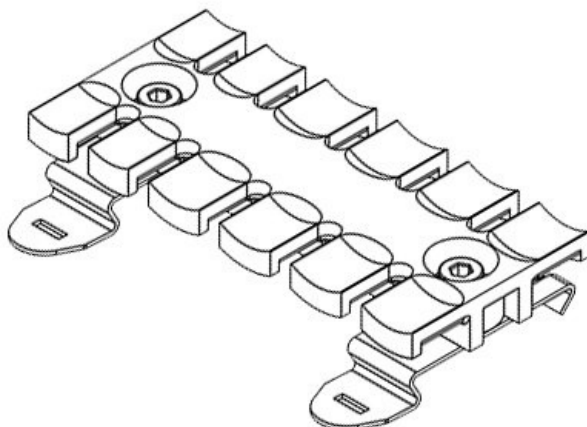

Part No.	<b>32354</b>	Mounting height	<b>11,4 mm</b>
EAN	<b>4251269301</b>	No. of teeth	<b>6</b>
Package quantity	<b>10</b>		
For max. no. of cables	<b>6</b>		
Length	<b>86,5 mm</b>		
Width	<b>51,7 mm</b>		
Height	<b>16 mm</b>		

SF|ZL 103

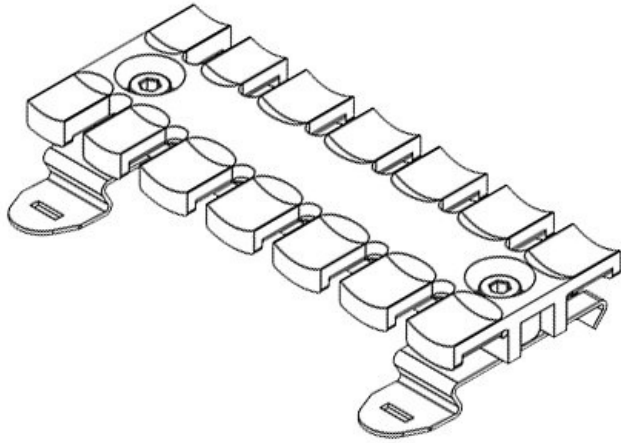

Part No.	<b>32355</b>	Mounting height	<b>11,4 mm</b>
EAN	<b>4251269301</b>	No. of teeth	<b>7</b>
Package quantity	<b>285</b>		
For max. no. of cables	<b>10</b>		
Length	<b>102,5 mm</b>		
Width	<b>51,7 mm</b>		
Height	<b>16 mm</b>		

SF|ZL 121

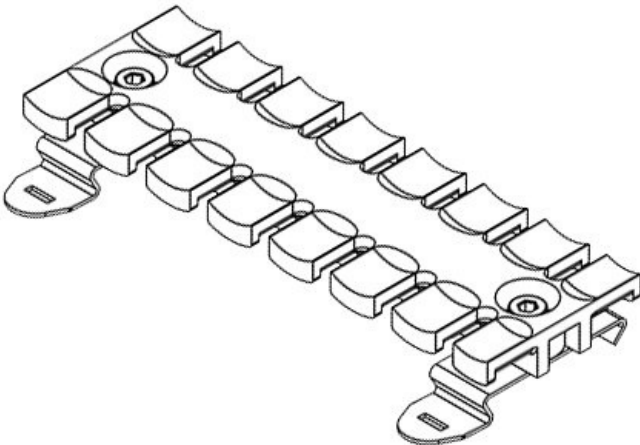

Part No.	<b>32356</b>	Mounting height	<b>11,4 mm</b>
EAN	<b>4251269301</b>	No. of teeth	<b>8</b>
Package quantity	<b>292</b>		
For max. no. of cables	<b>10</b>		
Length	<b>121 mm</b>		
Width	<b>51,7 mm</b>		
Height	<b>16 mm</b>		

SF|ZL 140

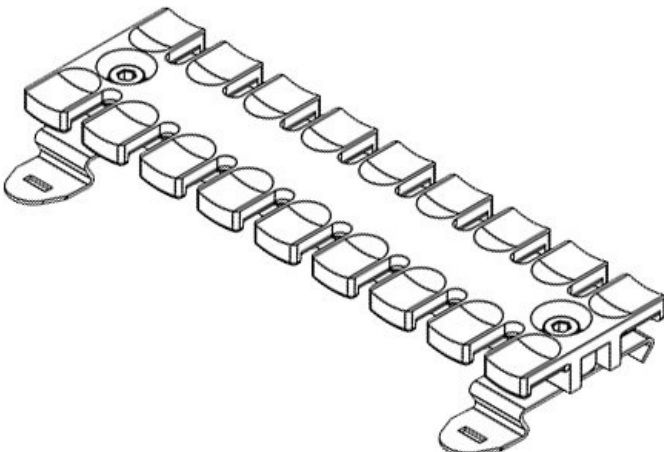

Part No.	<b>32357</b>	Mounting height	<b>11,4 mm</b>
EAN	<b>4251269301</b>	No. of teeth	<b>9</b>
Package quantity	<b>308</b>		
For max. no. of cables	<b>10</b>		
Length	<b>139,5 mm</b>		
Width	<b>51,7 mm</b>		
Height	<b>16 mm</b>		

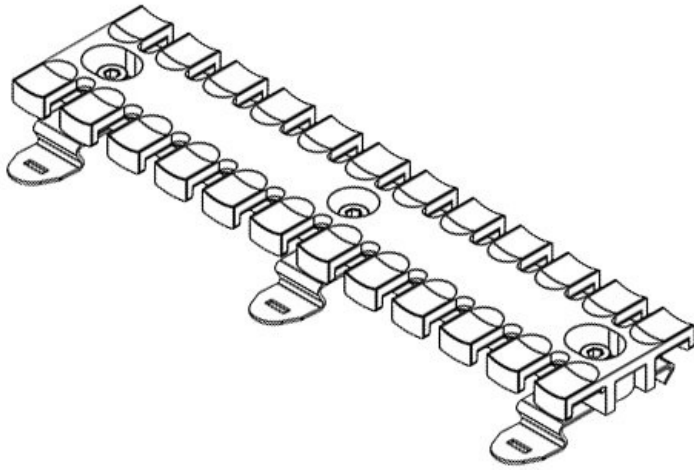

Part No.	<b>32358</b>	Mounting	<b>11,4 mm</b>
EAN	<b>4251269301</b>	height	
	<b>315</b>	No. of teeth	<b>12</b>
Package	<b>10</b>		
quantity			
For max. no. of	<b>12</b>		
cables			
Length	<b>180 mm</b>		
Width	<b>51,7 mm</b>		
Height	<b>16 mm</b>		